



NOEmagazine

Innovatief, doordacht en economisch



Vloerbekisting

Vloerbekisting Toebehoor

Afstandhouders en toebehoor

NOE Fundamentverspanning

NOE Ankerhulzen

NOEschwup \varnothing 15 mm en verankering \varnothing 15 mm

NOEplast

Ontkistingolie

Toebehoor

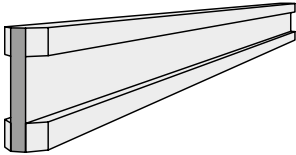
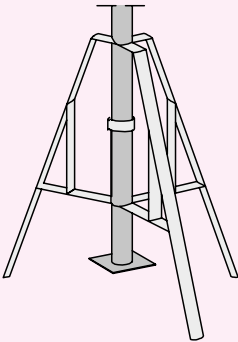
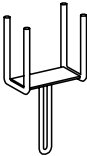
Benaming	Gewicht ca. kg	Artikel- nummer
<p>NOE H-20 drager</p> <p>Lengte 600 cm</p> <p>Lengte 490 cm</p> <p>Lengte 390 cm</p> <p>Lengte 330 cm</p> <p>Lengte 290 cm</p> <p>Lengte 250 cm</p>	 <p>30,00</p> <p>25,00</p> <p>20,00</p> <p>17,00</p> <p>15,00</p> <p>13,00</p>	<p>110600</p> <p>110490</p> <p>110390</p> <p>110330</p> <p>110290</p> <p>110250</p>
<p>Stempelstatief verzinkt</p>	 <p>11,00</p>	<p>900070</p>
<p>Kruiskop verzinkt</p>	 <p>3,00</p>	<p>110700</p>
<p>3-S Bekistingsplaat</p> <p>50 x 150 cm 21 mm dik</p> <p>50 x 200 cm 21 mm dik</p> <p>50 x 250 cm 21 mm dik</p>	<p>9,35</p> <p>10,05</p> <p>15,65</p>	<p>275000</p> <p>275100</p> <p>275200</p>

Balkbekisting en toebehoor

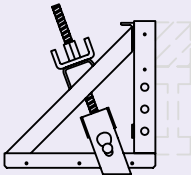
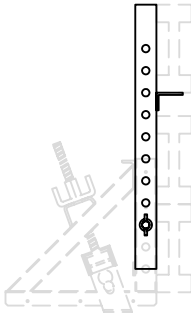

Benaming	Gewicht ca. kg	Artikel- nummer
Balkklem		
Geverfd 50/80 cm	9,00	407157
Spie ten behoeve van balkklem	0,05	407158
NOE UZ-Klem 300 voor onderslagbalken tot 300 mm hoogte verzinkt	6,00	110800
		
NOE UZ-Verlengstuk 600 Oplenging voor UZ-klem tot max. 600 mm hoogte verzinkt	6,00	110810
		
Klavetten en spanners		
Klavet 5–10 mm		407151
Spindelspanner		407153
Klavet met veer		407150
Spindelspanner met U-kop		407154
Spindelspanner met hefboom		407152

Afdichting stortnaden

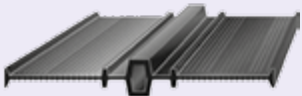

Benaming	Verpakkings- eenheid	Artikel- nummer
Superstop Waterdichte zwelband Groot uitzettingsvermogen (8x zijn droog volume) Dicht alle voegen en scheurtjes	doos/ 10 rol van 610 cm	407159
Gas omhulsel ten behoeve van superstop		407160
Lijm vulklem 116		407161
Waterkeerplaten Metaal 0,63/200 PVC-band 150	rol à 30 m rol à 25 m	407120 407121
Inwendige PVC stortvoegband 90LA19 90LA24	rol à 25 m rol à 25 m	407114 407115
PVC interne dilatatievoegband 90LD19 90LD24	 rol à 25 m rol à 25 m	407117 407118
Protax beschermdoppen Ten behoeve van wapening Ø 6–18 mm PRO 01 Ten behoeve van wapening Ø 16–30 mm PRO 02 Ten behoeve van wapening Ø 6–20 mm PRO 03	200 stuks 100 stuks 200 stuks	407122 407123 407124



Afstandhouders en toebehoor



Benaming	Verpakkings- eenheid	Artikel- nummer
----------	-------------------------	--------------------

Afstandbuis met waterkering

Inclusief RST dop

Opti D22 – 180

100 stuks **407001**

Opti D22 – 200

100 stuks **407002**

Opti D22 – 230

100 stuks **407003**

Opti D22 – 250

100 stuks **407004**

Opti D22 – 280

100 stuks **407005**

Opti D22 – 300

100 stuks **407006**

Opti D22 – 330

75 stuks **407007**

Opti D22 – 350

75 stuks **407008**

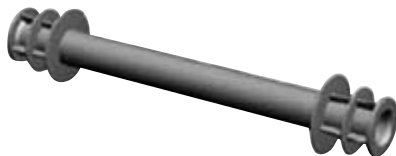

ERT 18

100 stuks **407011**

ERT 20

100 stuks **407012**

ERT 23

100 stuks **407013**

ERT 25

100 stuks **407014**

ERT 28

100 stuks **407015**

ERT 30

100 stuks **407016**

ERT 33



100 stuks **407017**

ERT 35

100 stuks **407018**



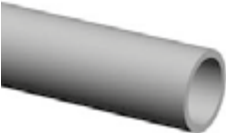
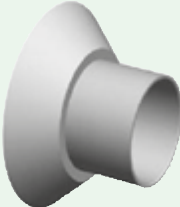

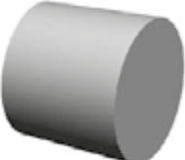
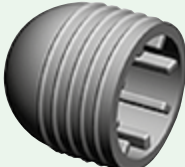
Afstandhouders en toebehoor



Benaming	Verpakkings-eenheid	Artikel-nummer
<p>Afstandbuis RS 22x26 mm lengte 200 cm RS 26x30 mm lengte 200 cm RS 30x36 mm lengte 200 cm</p>		<p>per stuk 407040 per stuk 407041 per stuk 407042</p>
<p>Konus SK 14/10 SK 22/10 SK 26/10</p>		<p>500 stuks 407044 500 stuks 407045 500 stuks 407046</p>
<p>Waterdichte konus RK 22 RK 26</p>		<p>500 stuks 407054 500 stuks 407055</p>
<p>Waterdichte stop RST 22 RST 26</p>		<p>500 stuks 407057 500 stuks 407058</p>
<p>Stoppen ST 22 ST 26</p>		<p>500 stuks 407049 500 stuks 407050</p>
<p>Rubberdop Flupp 22</p>		<p>500 stuks 407051</p>



Afstandhouders en toebehoor



Benaming	Verpakkings- eenheid	Artikel- nummer
Verticale afstandhouders		
UNI 15	1.000 stuks	407090
UNI 20	1.000 stuks	407091
UNI 25	1.000 stuks	407092
UNI 30	500 stuks	407093
UNI 35	200 stuks	407094
UNI 40	125 stuks	407095
UNI 50	100 stuks	407096
		
Tweeling afstandhouders		
Wanddikte x dekking		
150 x 25		407097
200 x 25		407099
250 x 25		407100
300 x 25		407101
150 x 30		407102
200 x 30		407104
250 x 30		407105
300 x 30		407106
400 x 30		407108
400 x 40		407110
Horizontale afstandhouders ASK		
ASK 20		407071
ASK 25		407072
ASK 30		407073
ASK 40		407074
PVC Profielen met afgebroken kant AL		
AL 20		407078
AL 25		407079
AL 30		407080
AL 35		407081
AL 40		407082
AL 50		407083

Afstandhouders en toebehoor



Benaming	Verpakkings- eenheid	Artikel- nummer
PVC Afstandsprofiel Steckfix		
ESSTF 15	100 cm	407085
ESSTF 20	100 cm	407086
ESSTF 25	100 cm	407087
ESSTF 30	100 cm	407088
ESSTF 35	100 cm	407089
		
Driekantlijsten		
Holle driekantlijst		
EL 10/10	100 m	407060
EL 15/15	100 m	407061
EL 20/20	100 m	407062
EL 25/25	50 m	407063
		
Holle driekantlijst met boord		
EM 11/2	100 m	407065
EM 15/3	100 m	407066
EM 20/3	50 m	407067
Waterdruiplijst		
EC 12	100 m	407069
EC 20	100 m	407070
Metaal afstandhouders		
Metaalstoel star		
ST 100	per stuk	407111
ST 120	per stuk	407112
ST 160	per stuk	407113
		

Stempels en schoring



Benaming	Gewicht ca. kg	Artikel- nummer
----------	-------------------	--------------------

NOE Euro schroefstempels

verzinkt

binnenbus Ø 51 x 3,3 mm

– buitenbus Ø 63,5 x 2,6 mm

B10 650 – 1000 mm

B15 1000 – 1700 mm

B25 1500 – 2600 mm

B35 1950 – 3500 mm

C45 2260 – 4100 mm

C55 3050 – 5500 mm



8,00	697210
10,00	697215
14,00	697225
17,50	697235
23,50	697345
31,50	697355

Afschoring

Duw- en trekschoor

Rocket binnenbus

Ø 48,3 x 3,2 mm –

buitenbus Ø 57 x 2,5 mm

verzinkt

100 – 170 cm

210 – 360 cm

310 – 540 cm

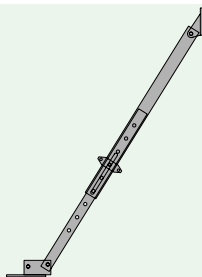

12,00	406040
17,00	406043
21,00	406060

Transportbakken

Schoorbak NOE

verzinkt 70 x 70 x 130

verzinkt 90 x 90



30,00	449997
14,00	449998

Stalen transportbak



60,00	449999
-------	---------------

Stekkenbakken



Benaming

Artikel-
nummer

Stekkenbakken

Doos in gegalvaniseerd staal

Standaardlengten 125 cm

– andere maten op aanvraag

FX 50	150 x 50 mm	Dia 8 mm	407125
		Dia 10 mm	407127
	200 x 50 mm	Dia 8 mm	407126
		Dia 10 mm	407128
FX 120	150 x 90 mm	Dia 8 mm	407129
		Dia 10 mm	407131
	200 x 90 mm	Dia 8 mm	407130
		Dia 10 mm	407132
FX 150	150 x 120 mm	Dia 8 mm	407133
		Dia 10 mm	407135
	200 x 120 mm	Dia 8 mm	407134
		Dia 10 mm	407136
FX 170	150 x 140 mm	Dia 8 mm	407137
		Dia 10 mm	407139
	200 x 140 mm	Dia 8 mm	407138
		Dia 10 mm	407140
FX 190	150 x 160 mm	Dia 8 mm	407141
		Dia 10 mm	407143
	200 x 160 mm	Dia 8 mm	407142
		Dia 10 mm	407144
FX 230	150 x 200 mm	Dia 8 mm	407145
		Dia 10 mm	407147
FXJ 170	200 x 200 mm	Dia 8 mm	407146
		Dia 10 mm	407148
	150 mm	Dia 8 mm	407148
		Dia 10 mm	407149



B&T ankers en toebehoor



Benaming	Gewicht ca. kg	Artikel- nummer
Kombi leuningspijl met gelaste haken	2,50	403978
Horizontaal adapter	0,60	403980
Kombi-anker	0,07	403040
Adapter schroefkoppeling ten behoeve van Kombi Max	0,70	403980
Kombi Max voor horizontale en verticale bevestiging in de beton en voor H20 of vellingkant	1,70	403979
B&T Ankers & Toebehoor Nagelstop jumbo	0,008	403972
B&T Ankers & Toebehoor Nagelstop jumbo 50	0,022	403973
B&T Ankers & Toebehoor Mantelpijpconus jumbo 50	0,030	403974
B&T Ankers & Toebehoor Kombi-Fix 45 Inbouw hulp voor eenzijdige bekisting te verankeren onder 45°	0,022	403975
B&T Ankers & Toebehoor Kombihuls zilver	0,10	403976
B&T Ankers & Toebehoor Kombihuls titan	0,04	403977

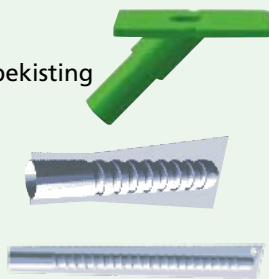

NOE Fundamentverspanning



De NOE Fundamentklemmen passen op ieder bekistingssysteem, zoals Doka, Hünnebeck, Meva, NOE, Paschal en Peri.

- **Hoge kostenbesparing**
ten opzichte van conventionele methodes
- **Gereduceerde**

- **Rastervrij bekisten**
Met centergaten hoeft geen rekening gehouden te worden
- **Mantelbuizen vervallen**
De verspanning gaat onder- en bovenlangs de panelen
- **Onderste verspanning ligt onder de bekisting**
Vullingen onder de bekisting zijn geen noodzaak meer

- **Ook bij een krappe werkruimte inzetbaar**
- **belastbaar**
16 kN toelaatbare trekkracht van de fundametaklem
- **Op één lijn uitrichten**
door het bevestigen van de fundametaklem op de werkvloer

■ Maximale afstand tussen de bandstalen strippen

(per paneel minstens 2 bandijzers)

tot 0,80 m storthoogte	2,20 m
tot 1,00 m storthoogte	1,40 m
tot 1,30 m storthoogte	0,85 m

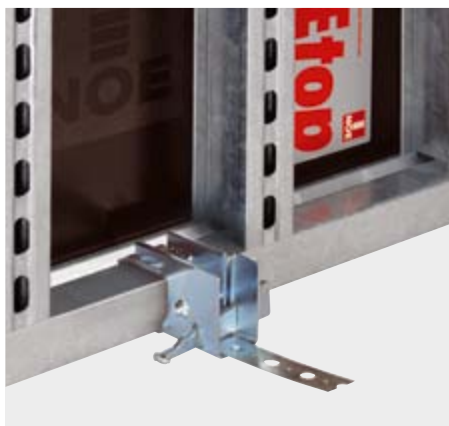
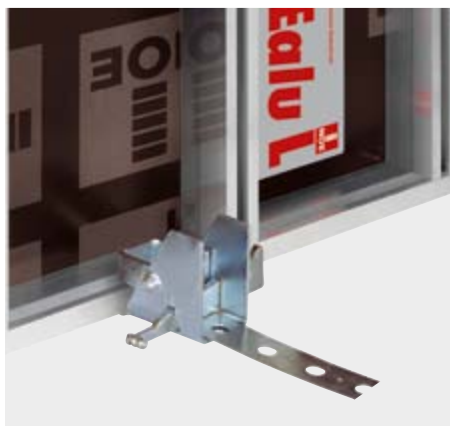

NOE Fundamentklem

in te zetten met NOE bandstaal, zwart, bijvoorbeeld voor

Benaming	Gewicht ca. kg	Artikel- nummer
NOEtop / NOEtop Alu	1,70	137297
NOEalu L	1,11	402500

Fundamentklemmen voor andere bekistingen op aanvraag

NOE Bandstaal zwart levering in rollen van 50 m toelaatbare trekkracht 16 kN		0,40/m	108029
-------------------------------------------------------------------------------------------	-----------------------------------------------------------------------------------	--------	---------------

NOE Bandstaal snijwagen Houder voor bandstaal inclusief afsnijgereedschap voor het eenvoudig, precies en veilig afsnijden van bandstaal.		21,80	108030
----------------------------------------------------------------------------------------------------------------------------------------------------------------	------------------------------------------------------------------------------------	-------	---------------

NOE Ankerhuls



- Gemaakt van polyamide
- voor DW Ø 15 mm
- Gecertificeerd
- Onverwoestbaar en robuust
- Flexibel en belastbaar
- Omvangrijk toebehoor

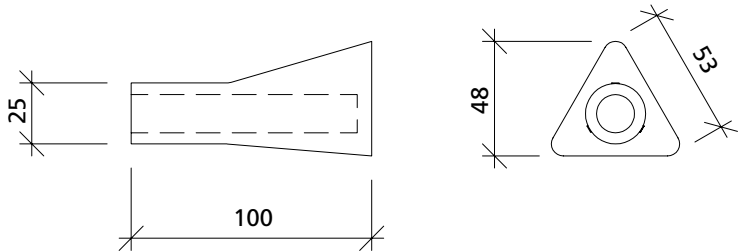

Belastingsdiagram NOE Ankerhulzen (zonder randinvloed)

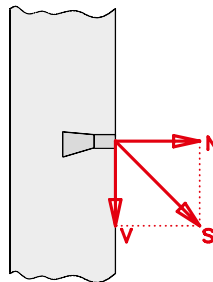
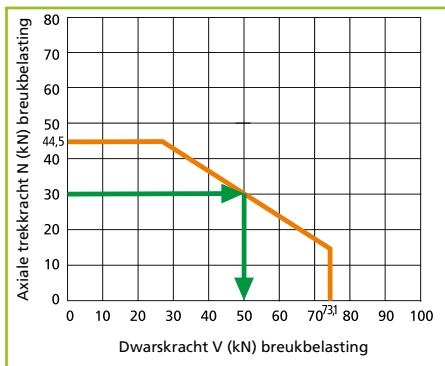







Voorbeeld:

bij 30 kN trekkracht = max. dwarskracht 50 kN

De waarden hebben betrekking op één NOE Ankerhuls
Waarden voor betondichtheid: 15 N/mm²

NOE Ankerhuls

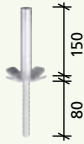

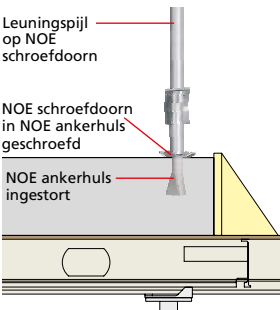
Benaming	Gewicht ca. kg	Artikel- nummer
<p>NOE Ankerhuls D 15 Polyamide, voor DW Ø 15 mm verpakking per 50 stuks</p> 	0,087	694910
<p>NOE Nagelplaat D 15 Polyamide verpakking per 250 stuk</p> 	0,008	694930
<p>Gummimagneet met Schwupdraad, Ø 15 mm met kunststof ommanteling</p> 	0,32	694980
<p>NOE Ankerhuls nagelstop D 15 Polyamide verpakking per 250 stuks</p> 	0,004	694920
<p>NOE Ankerhuls afsluitstop D 15 Polyamide verpakking per 250 stuks</p> 	0,002	694940
<p>Leuningspijl doorn Ø 24,5 mm, verzinkt</p> 	0,84	111402
<p>Leuningspijl 1260 mm hoog, verzinkt</p>  <p>Leuningspijl op NOE schroefdoorn</p> <p>NOE schroefdoorn in NOE ankerhuls geschroefd</p> <p>NOE ankerhuls ingestort</p> 	3,74	111400

NOE *schwup* toebehoren voor *schwup*staaf Ø 15 mm







Niet lasbaar

Belastbaarheid in acht nemen!







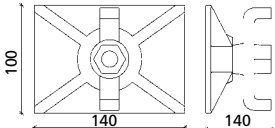

Schwupstaaf, kern Ø 15 mm, buitendiameter Ø 17 mm, voor het centeren van **alle** bekistingssystemen. Van

eenvoudige hout-bekisting tot moderne grootvlakpanelen. Toelaatbare trekkkracht 90 kN (volgens DIN 18216)

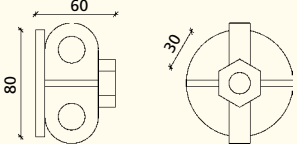
Benaming		Lengte mm	Breedte mm	Gewicht ca. kg	Artikel- nummer
Schwup spanstaaf verzinkt afgeschuind, kern Ø 15 mm, buitendiameter Ø 17 mm		1500		2,12	671500
		1250		1,78	671250
		1000		1,43	671000
		950		1,36	670950
		750		1,07	670750
		500		0,71	670500
	300		0,42	670300	
Gegolfd anker Ø 15 mm		700		0,85	542007
Ankerhaak Ø 15 mm		450		1,05	542005
Ankerlus Ø 15 mm		630		2,20	542006

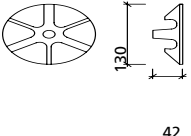
NOE *schwup* toebehoren voor *schwup*staaf Ø 15 mm

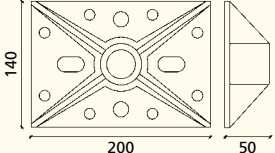

Benaming	Lengte mm	Breedte mm	Gewicht ca. kg	Artikel- nummer
<p>Volgplaat met kantelbare moer verzinkt</p>  	140	100	1,20	691700
<p>Schwup sprint Oplegvlak Ø 80 mm, verzinkt</p>  	Ø 80		0,69	680580
<p>Schotelmoer Ø 130 mm, verzinkt</p>  	Ø 130		0,90	680590
<p>Oplegplaat boorgat Ø 32 mm verzinkt</p>  	140	200	1,70	691200



NOE *schwup* toebehoren voor *schwup*staaf Ø 15 mm



Benaming	Lengte mm	Breedte mm	Gewicht ca. kg	Artikel- nummer
Oplegplaat boorgat Ø 20 mm verzinkt	120	120	1,08	691400
				
Schwup vierkantmoer (lasbaar)	60	30	0,42	681300
				
Schwup zeskantmoer verzinkt, SW 30	30 60	30 30	0,13 0,26	680900 681000
				
Schwup koppelingsmoer SW 30 toelaatbare trekkracht 90 kN, verzinkt	105	34	0,45	684000
				
Schwup oogmoer voor spanstaaf Ø 15 mm boorgat Ø 17 mm lasbaar toelaatbare trekkracht 70 kN			0,40	117240
				
Driehoeks centering toelaatbare trekkracht 64 kN			3,10	682500
				

NOEschwup toebehoren voor schwupstaaf Ø 15 mm



Benaming	Lengte mm	Breedte mm	Gewicht ca. kg	Artikel- nummer
Betonanker B 15 voor Schwup Ø 15 mm, toel. trekkracht 90 kN in beton > C 20/25			0,27	541090
Bevestigingsbeugel DW Ø 15 mm			0,40	542001

NOEplast Jaartal*

Mattengrootte
 430 mm (A) x 255 mm (B)
 Maattoleranties
 A / B ± 1 %
 Mattensterkte ± 2 mm
 Gewicht ca. 2,4 kg
 Shore hardheid A 65-70
 Temperatuur-
 bestendigheid + 80 °C

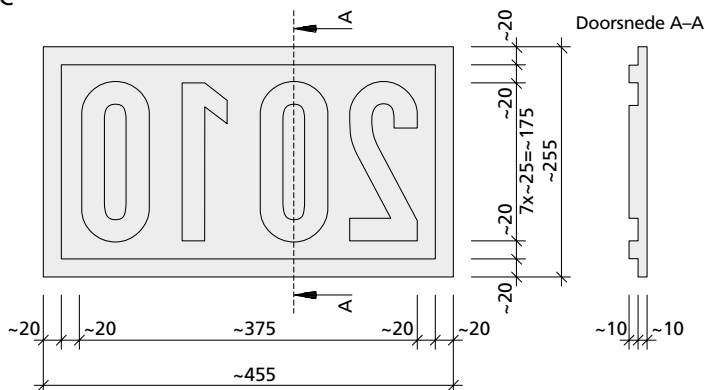

Benaming	Lengte mm	Breedte mm	Hoogte mm	Gewicht ca. kg	Artikel- nummer
Jaartal	455	255	20	2,40	569000

Bij bestelling s.v.p. het gewenste jaartal opgeven.

NOEfix PU fixeerschijf

voor PVC-buizen voor het fixeren van ronde uitsparingen in betonnen prefabdelen en funderingen





- eenvoudige bevestiging aan de bekisting
- 10 mm kant, 45°
- sluit aan op de bekisting
- herbruikbaar
- schoon glad oppervlak



Benaming	Gewicht ca. kg	Artikel- nummer
NOEfix PU fixeerschijf voor PVC-buizen		
50 (56 x 1,8)	0,28	569071
70 (75 x 1,9)	0,39	569072
100 (110 x 3,0)	0,40	569080
125 (125 x 3,0)	0,68	569082
150 (160 x 3,6)	0,84	569084
200 (200 x 4,5)	1,45	569086
250 (250 x 6,1)	1,80	569073
300 (315 x 7,7)	2,18	569074
400 (400 x 9,8)	2,90	569075

Ontkistingsolie



Benaming	Gewicht ca. kg	Artikel- nummer
NOE/los Uitstekend geschikt voor NOEplast structuurmatten. 200 liter vat 60 liter vat 20 liter can 5 liter can		186,00 kg 404560 53,00 kg 404570 18,00 kg 404571 4,50 kg 404580
Rugnevelspuit Chapin Tri-Poxy 7,6 liter		7,00 407169
Reserve sproeikop	0,15	407170
Dichtingsset	0,30	407171

Benaming	Gewicht ca. kg	Artikel- nummer
<p>Ankerschroef MMS M 14x130 Verpakking per 25 stuks Boordiameter 12 mm minimale betondikte 150 mm minimale bevestiging 95 mm maximale plaatdikte 35 mm SW21</p>	0,13	313150



<p>Leuninghouder schroefbaar Klembereik tot 400 mm Inzet tot 40 m Afstand max. 2 m, gelakt</p>	7,20	900050
----------------------------------------------------------------------------------------------------------------------------------------------------------------------------------	------	---------------



Benaming	Lengte mm	Gewicht ca. kg	Artikelnummer
----------	-----------	----------------	---------------

Bekistinghamer



0,90 **395000**

NOE Montagedoorn

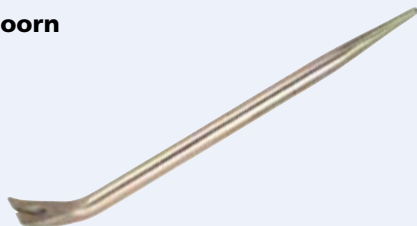

1,20 **398200**

Spanband 2,5 t

Met triangelhaken
 Bandbreedte 50 mm
 Lengte 8000 (7500-500 mm)
 Alleen om te sjoorren,
 niet om lasten te tillen

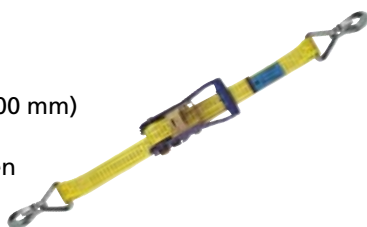

8000 2,80 **990013**

NOE Bekistingstechniek N.V.

Kantoor
 Leuvensesteenweg 613
 1930 Zaventem
 Telefoon 02 / 757.64.16
 Telefax 02 / 757.64.18
 E-Mail info@noe.be · www.noe.be

Depot
 Brusselsesteenweg 73 a
 9090 Melle (Gent)
 Telefoon 09 / 230.16.99
 Telefax 09 / 231.55.91

