



DE BETONBEKISTING



NOE[®]tec

Montagebekisting



NOEtec – maatwerk voor civiele en hoogbouwprojecten



Maatwerk

Vrijwel elke vorm is met het NOEtec systeem te realiseren.



Weinig onderdelen

NOEtec realiseert gecompliceerde projecten met een minimum aan systeemonderdelen.

Veelzijdig

NOEtec – universeel inzetbare montagebekisting voor alle mogelijke projecten.

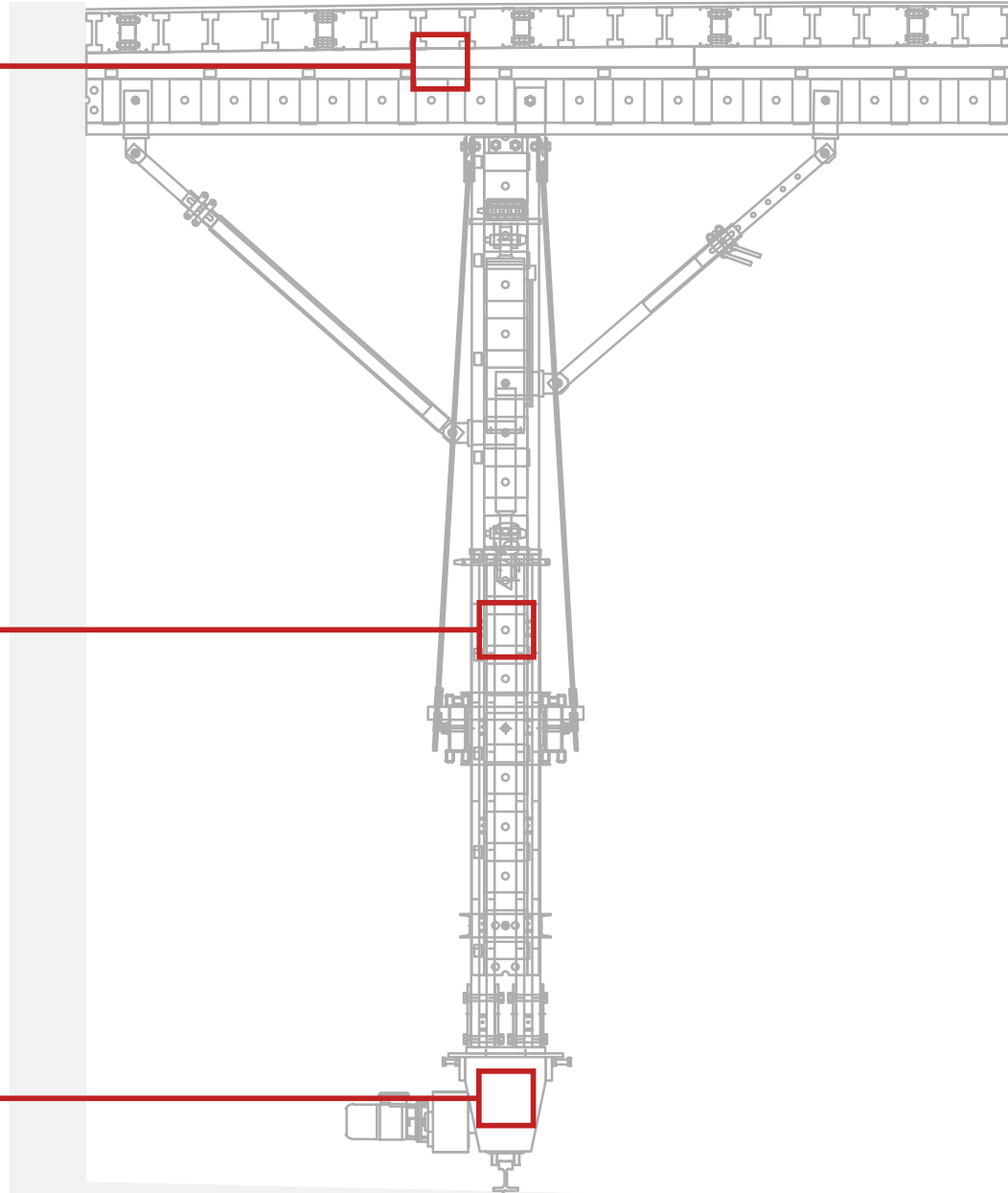

Uitsluitend systeemonderdelen

Een tunnel met rechthoekige of ronde doorsnede, bergbouw of open bouwwijze, wandbekisting of ruimtelijke ondersteuningsconstructie: ieder project is vrijwel uitsluitend met systeemonderdelen te realiseren.



NOEtec – gecompliceerde projecten eenvoudig te realiseren.



Veilig

NOEtec biedt een hoge mate aan arbeidsveiligheid.

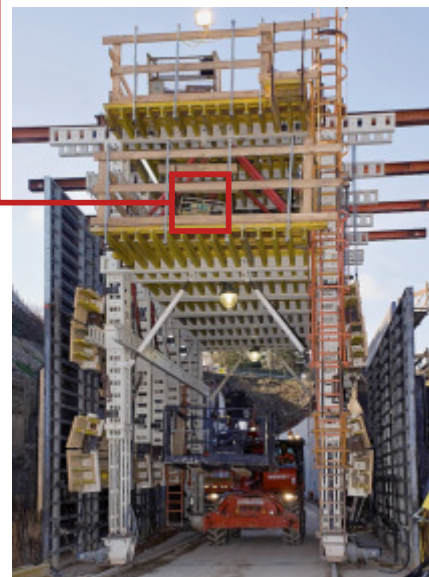

Snel

NOEtec overtuigt door korte montage-tijden en voor de hand liggende opbouw.

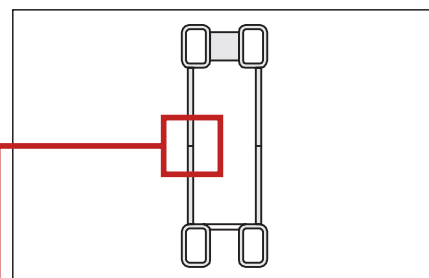
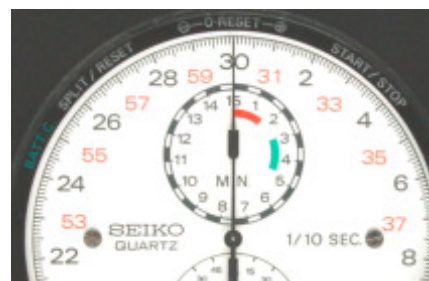

Duurzaam

Alle onderdelen van het systeem zijn van staal en gelakt.

Belastbaar

NOEtec bewijst zich door hoge draaglasten.

Statische waarden:

A =	42,69 cm ²
G =	50 kg/m
I _y =	8544 cm ⁴
M _{yzul} =	109 kNm
V _{yzul} =	349 kN

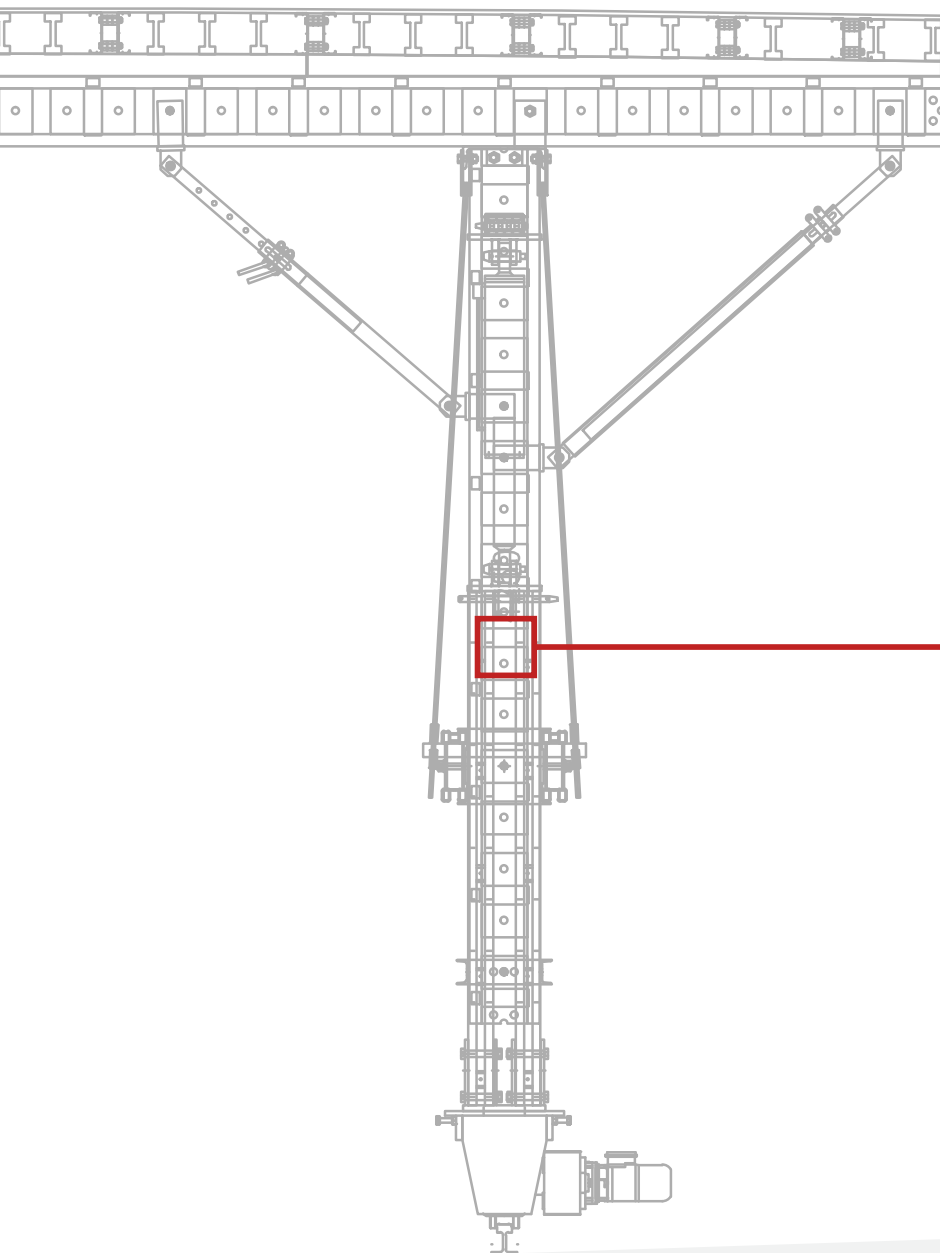

NOEtec – overtuigend door heldere, overzichtelijke opbouw



NOEtec ligger

De basis van het systeem



NOEtec bout

Het enige verbindingsdeel



NOEtec normaalaansluiting



NOEtec spindel



NOEtec montagekrans

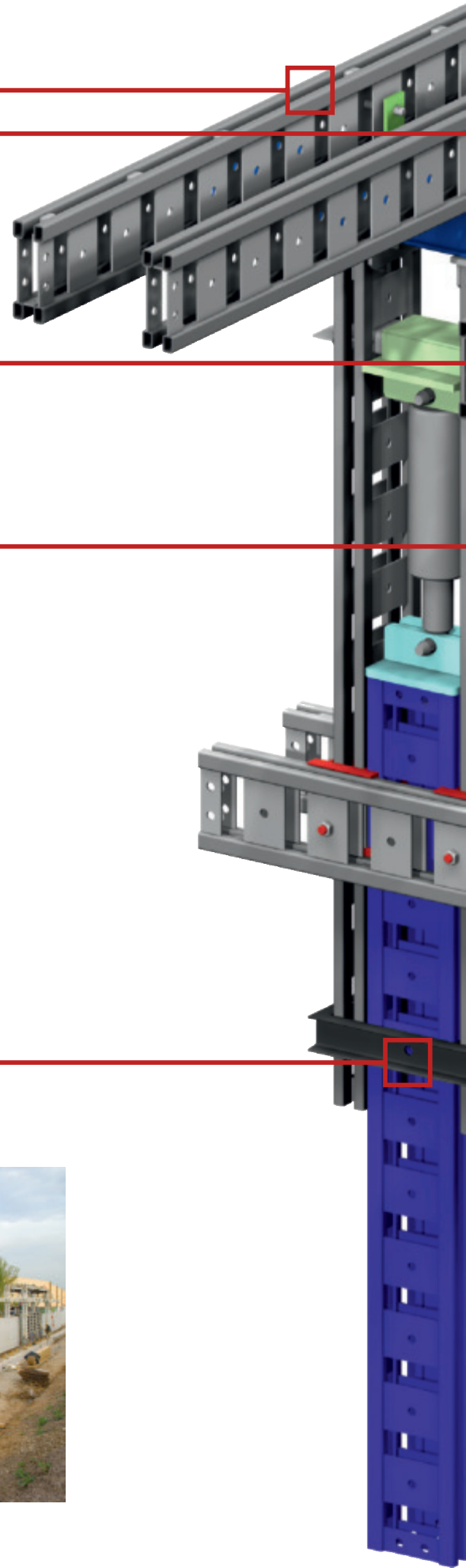
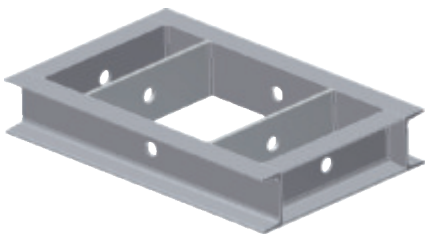

NOEtec helder eenduidige opbouw

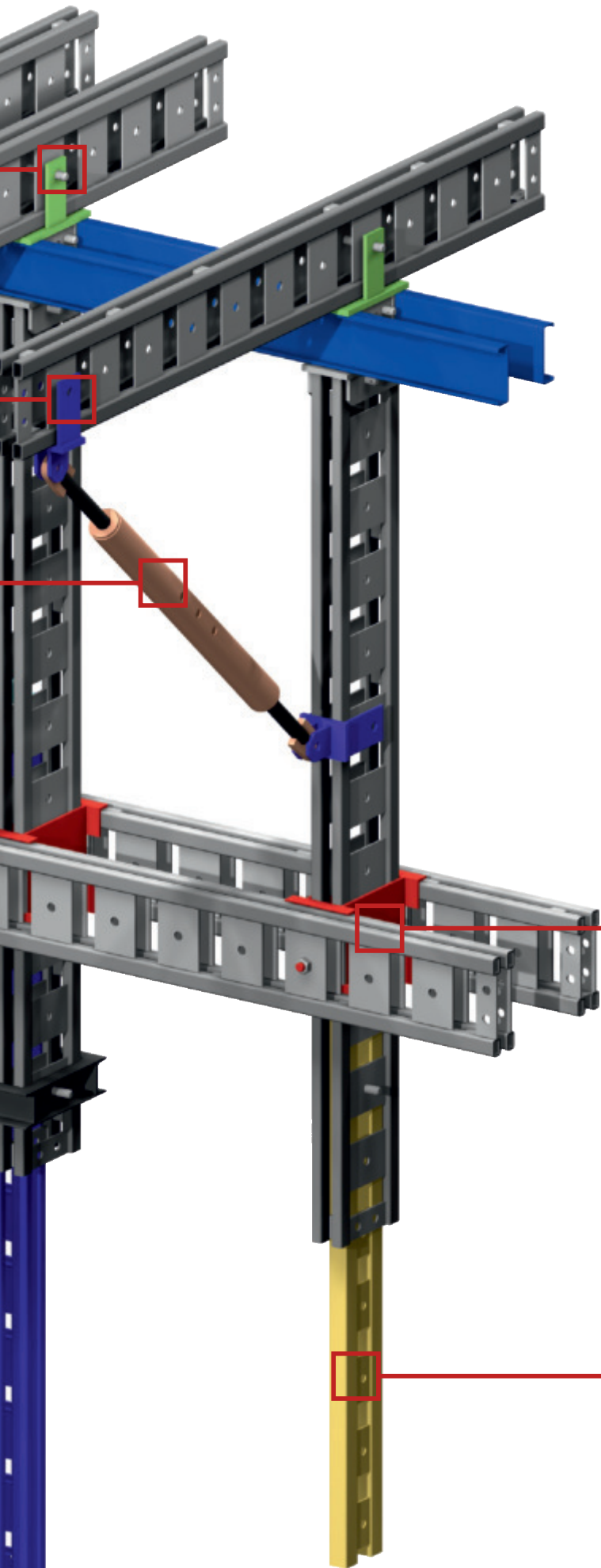

NOEtec koppelstuk

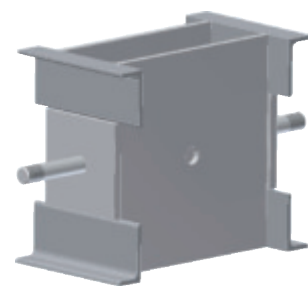

NOEtec schuifligger



NOEtec – technisch en economisch overtuigend



Inzet als trogbekisting

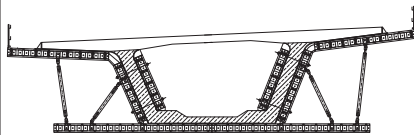

Inzet als wandbekisting

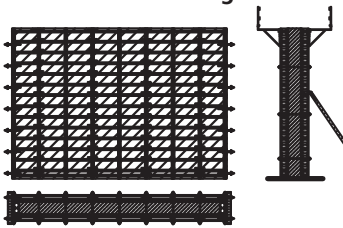

Inzet als klimbekisting

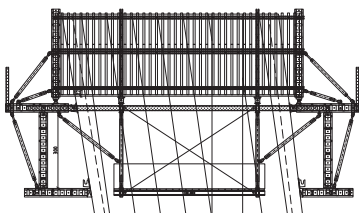

Inzet als werkbordes

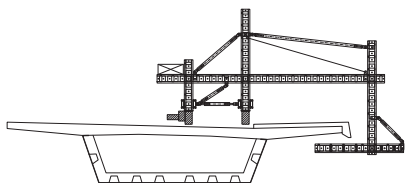

NOEtec – slimme oplossingen voor civiele bouwprojecten



Inzet als ondersteuningsconstructie

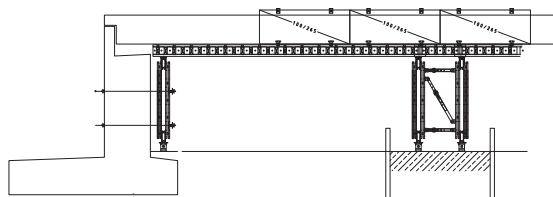

Inzet als tunnelwagen

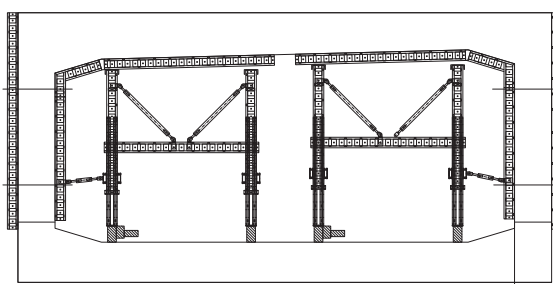

Bekisting voor brugconstructie

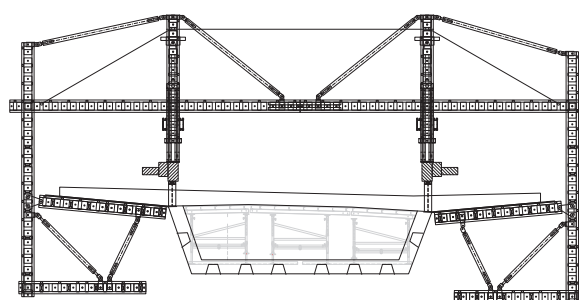



DE BETONBEKISTING

Nederland NOE-Bekistingtechniek b.v.

Postbus 25, 4240 CA Arkel
Vlietskade 1009, 4241 WD Arkel
T + 31 183 56 98 88
F + 31 183 56 33 17
info@noe.nl
www.noe.nl
www.noeplast.com
www.betonvormgeving.nl

België NOE-Bekistingtechniek N.V.

Leuvensesteenweg 613, 1930 Zaventem
T + 32 2 757 64 16
F + 32 2 757 64 18
info@noe.be
www.noe.be
www.noeplast.com

Hoofdkantoor

NOE-Schaltechnik Georg Meyer-Keller GmbH & Co. KG

Kuntzestr. 72, 73079 Süssen
Duitsland
T +49 7162 13-1
F +49 7162 13-288
info@noe.de
www.noe.de
www.noeplast.com

Brazilië

Mills do Brasil
Estruturas e Serviços Ltda.
www.mills.com.br
millsbr@cepa.com.br

Bulgarije

NOE-Schaltechnik
www.noebg.com
noe-bg@netbg.com

Frankrijk

NOE-France
www.noe-france.fr
info@noe-france.fr

Kroatië

NOE oplatna tehnika d.o.o.
www.noe.hr
noe@noe.hr

Oostenrijk

NOE-Schaltechnik
www.noe-schaltechnik.at
noe@noe-schaltechnik.at

Polen

NOE-PL Sp. Zo.o.
www.noe.com.pl
noe@noe.com.pl

Rusland

NOE Moskau
info@noe-moscow.ru

NOE St. Petersburg
noe@sovintel.ru

Saudi-Arabië

Global NOE Trade Est.
NOE – The Formwork
www.noe.de
jeddah@noe.de

Servië

NOE Sistemske Oplate d.o.o.
www.noe-scg.com
noe-scg@eunet.rs

Zwitserland

NOE-Schaltechnik
www.noe.ch
info@noe.ch